



TMC-212

Residential and Commercial Irrigation System Controller

User's Guide



Congratulations! You have chosen one of the most sophisticated and technologically advanced irrigation system controllers available for residential and light-commercial applications.

Your new Toro TMC-212 controller features:

- **Flexible Station Count from 2 to 12 Stations with 2-station Expansion modules:**
 - **Standard and High-surge Expansion Modules**
- **Locking Outdoor Cabinet**
- **Automatic Pump Start/Master Valve Control Circuit**
- **365-day Calendar**
- **3 Fully-independent Watering Programs Featuring:**
 - **4 Start Times**
 - **3 Watering Day Schedule Options:**
 - **7-day Calendar**
 - **7-day Interval with Day Exclusion**
 - **Odd/Even Days with Day Exclusion**
 - **Station Time from 1 Minute to 4 Hours**
 - **Pump Start/Master Valve Timing Control**
 - **Well Recovery/Station Delay Time**
- **Season Adjust from 10 to 200%**
- **Rain Delay from 1–7 Days**
- **Automatic Program/Start Time Stacking**
- **Rain Sensor Ready:**
 - **Compatible with All Rain Sensor Types**
 - **Sensor Circuit Bypass Switch**
- **Remote Control Ready**
- **Automatic Circuit Protection—Eliminates Fuse**
- **Non-volatile Program Memory—Eliminates Battery**

The TMC-212 controller features several unique and helpful operating characteristics. To take advantage of these features, spend just a few minutes to browse through this manual to familiarize yourself with your new controller.

This booklet is divided into six main sections:

- The first section provides a brief description of the controller components and display elements.
- The second section takes you step-by-step through the installation process.
- The next section provides fundamental irrigation system operation, basic controller operation as well as specific programming and operating characteristics of the TMC-212.
- The fourth section takes you step-by-step through the programming process.
- The fifth section explains the various methods of automatic and manual controller operations.
- Finally, an appendix provides helpful reference information, troubleshooting, specifications and warranty information.

A convenient watering schedule form (affixed to the cover of the outdoor model controller and included on page 20) enables you to record and keep specific station and watering program information on hand with your controller.

The Quick Reference Guide provided with your User Guide should also be kept with your controller. The booklet fits conveniently between the cabinet back and the mounting bracket of the Indoor model. For Outdoor model controllers, hang the booklet on the hook provided inside the cabinet cover.

Table of Contents

Controller Components.....2

Controller Installation

- **Indoor Model Installation**6
 - Connecting the Valves7
 - Connecting a Pump Start Relay8
 - Connecting the Transformer8
- **Outdoor Model Installation**9
 - Preparing the Cabinet for Installation.....9
 - Installing the Cabinet.....10
 - Connecting the Valves11
 - Connecting a Pump Start Relay.....12
 - Connecting the Power Source13
- Connecting a Rain Sensor.....13

Getting Started

- Irrigation System Basics14
- Watering Program Basics15
- Watering Program Details.....16
- Planning Your Watering Schedule.....18
- Filling Out the Watering Schedule Form.....18
 - Watering Schedule Form20

Programming the Controller

- About the Controller Memory21
- Setting the Current Time and Day or Date21
- Setting the Watering Day Schedule.....22
 - Setting a Calendar Schedule22
 - Setting an Interval Schedule23
 - Setting an Odd or Even Schedule.....24
 - Using the Day Exclusion Feature25

- Turning Off a Program26
- Setting Program Start Times27
- Setting Station Times.....28
- Setting Pump/Master Valve and Well Recovery Controls28

Controller Operations

- **Automatic Mode**30
- **Manual Mode**31
 - Operate Watering Program(s).....31
 - Operate Stations31
 - Watering Control Features32
 - Pause Watering32
 - Resume Watering32
 - Cancel Watering32
 - Skip Stations.....32
 - Adjust the Station Time During Operation ..33
- Rain Delay Feature.....33
- Season Adjust Feature34
- Turn Off Operation.....35

Appendix

- Clearing the Program Memory.....36
- About Automatic Circuit Protection37
- Adding a 2-Station Expansion Module.....37
- Using Pump/Master Valve Controls.....38
- Troubleshooting40
- Specifications.....41
- Warranty42
- Electromagnetic Compatibility42

Controller Components

Controller Components

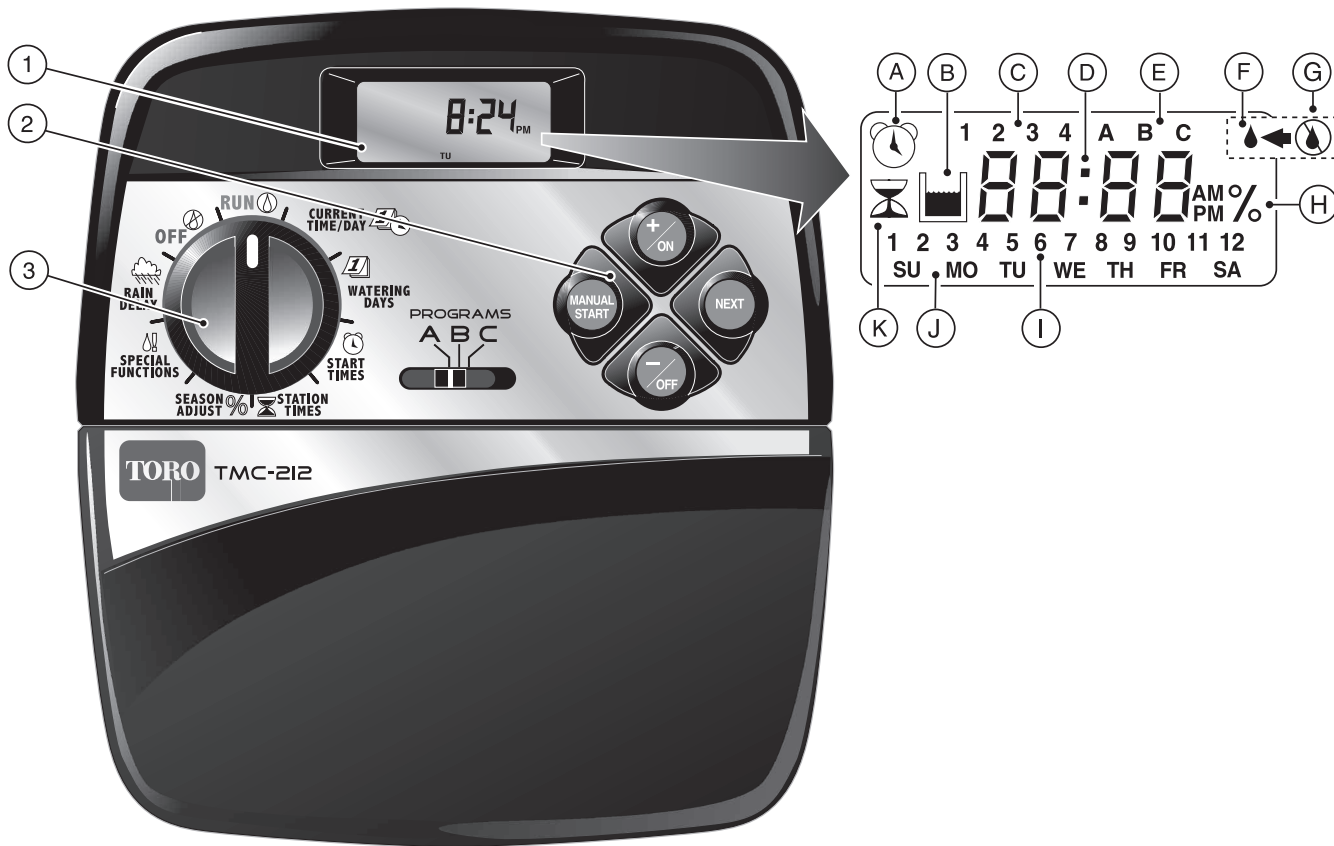

Controller Components

The following are brief descriptions of the controller components and display elements. Each of these items will be explained in further detail within the appropriate programming, operating and installation sections of this guide.

1 - LCD Display

- A** - “Start Time” symbol is displayed when setting the program start times.
- B** - “Well Recovery” symbol is displayed when well recovery time delay is in use.
- C** - Program start time identification numbers 1–4.
- D** - Main display of various time values and prompts.
- E** - Program A, B and C identifiers.
- F** - “Watering On” symbol is displayed when a watering station is running. Symbol blinks when watering is paused.
- G** - “Watering Off” symbol is displayed when Rain Delay feature is active.
- H** - “Percent” symbol is displayed when the Season Adjust feature is in use.
- I** - Watering Station identification numbers.
- J** - Day of the week identifiers.
- K** - “Run Time” symbol is displayed when setting the watering station run times.

2 - Control Buttons

+ / ON button – Increases the time display, scrolls forward through the program information and selects watering days.

- / OFF button – Decreases the time display, scrolls backward through the program information and removes watering days.



NEXT button – Advances to the next portion of program information. Resumes watering if paused. Advances through stations manually when watering.

MANUAL START button – Selects and starts manual watering operations.

3 - Control Dial – Selects all controller programming and operation controls (except Manual Start).

Control Dial Positions

RUN  – The normal dial position for all automatic and manual operations.

CURRENT TIME/DAY   – Enables the clock time and day to be set.

WATERING DAYS  – Enables the watering day schedules to be set and reviewed.

START TIMES  – Enables the program start times to be set and reviewed.

STATION TIMES  – Enables the station run time to be set and reviewed.

(CONTINUED)

Controller Components

SEASON ADJUST % – Enables the station time of all stations in a program to be simultaneously increased or decreased in 10% increments.

SPECIAL FUNCTIONS ⚠! – Provides optional control and timing features for pump operation and well recovery delay feature.

RAIN DELAY  – Enables all watering operations to be delayed from 1 to 7 days.

OFF  – Shuts off and prevents all automatic and manual watering activity.

- 4 - Program Select Switch** – Three-position slide switch used to select watering program A, B or C during the programming procedures and manual operation.
- 5 - Rain Sensor Circuit Control Switch** – Enables the Rain Sensor circuit to be bypassed as necessary.
- 6 - Rain Sensor Configuration Switch** – Configures the controller for operation with a Normally-open or a Normally-closed rain sensor.
- 7 - Rain Sensor Connection Terminals** – Snap-in wire connectors for direct connection of a Rain Sensor.
- 8 - Valve Common Connection Terminal** – Snap-in wire connector for the valve common wire.
- 9 - Pump/Master Valve Connection Terminal** – Snap-in wire connector for connection of a pump start relay or master valve 24 VAC power wire.
- 10 - Transformer Connection Terminals** – Snap-in connectors for transformer wires.

- 11 - Two-station Expansion Module (Standard and High-surge Protection Models)** – Each expansion module provides a snap-in wire connection for two stations. Up to six modules can be installed to expand the TMC-212 control from 2 to 12 stations. Standard-surge expansion module TSM-02 provides 1.3 Kv surge protection per station and is identified by a single lightning bolt symbol and black color. High-surge protection module TSM-02-H provides 6.0 Kv surge protection per station and is identified by two lightning bolts, beige color and extended length. While both types of expansion modules are interchangeable with all TMC-212 models, the TSM-02-H module can only provide 6.0 Kv surge protection when installed in specially-equipped controller models TMC-212-ODH and TMC-212-ODH-50H.
- 12 - Remote Control Receiver Jack** – Modular jack provided for the connection of the optional Toro EZ-Remote™ remote control receiver cable. (Installation and operating instructions are provided with the EZ-Remote control system.)
- 13 - External Transformer** – A Plug-in transformer supplies 24 VAC power to the indoor model controller.
- 14 - Internal Transformer** – A built-in transformer supplies 24 VAC power to the outdoor model controller.
- 15 - Input Power Terminal Block** – Connection terminals for AC power wires.

Controller Components

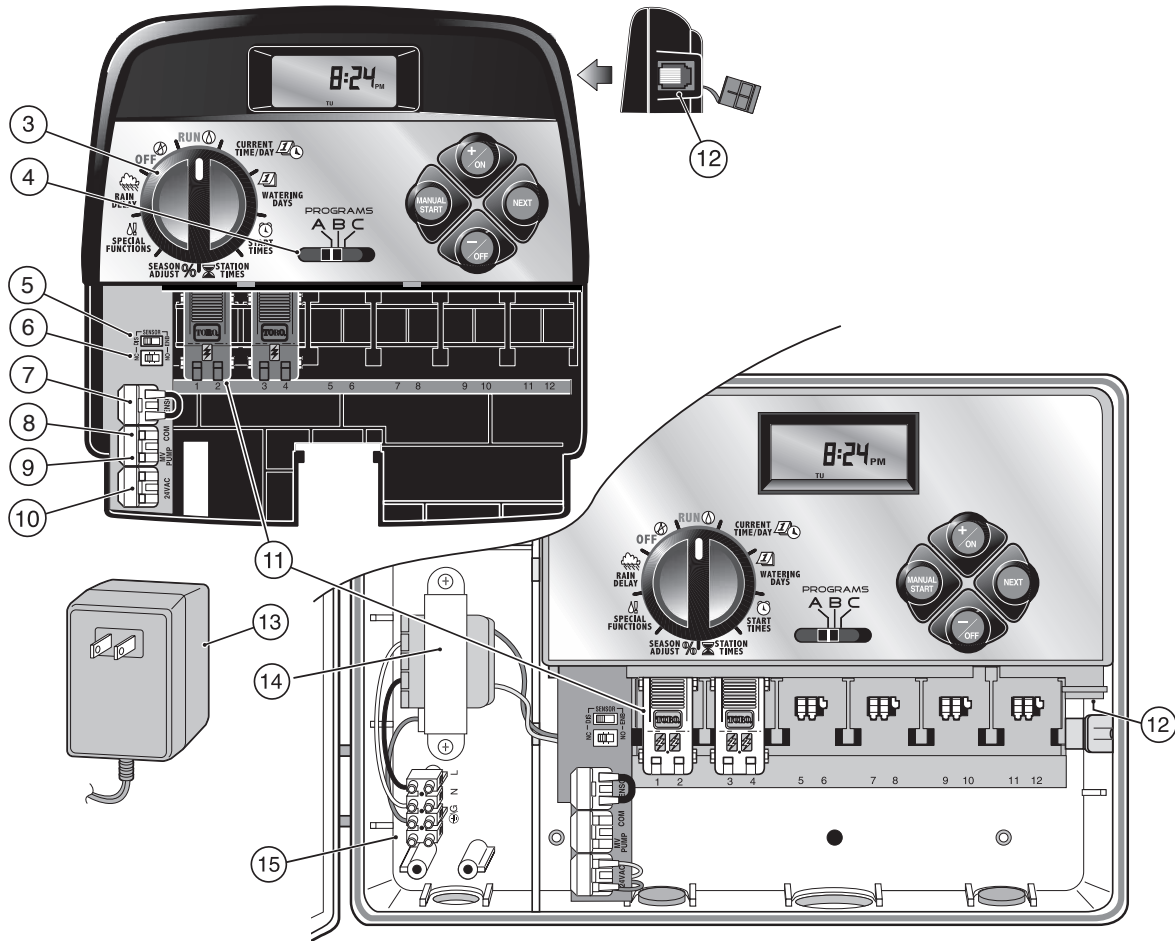

Controller Installation

▲ IMPORTANT: TMC-212 indoor model is not weather resistant and must be installed indoors or in a protected location.

Indoor Model Installation

1. Select a location for the controller within 4' (1.2 m) of an electrical outlet to enable the transformer wires to easily reach. Make sure the outlet is not controlled by a light switch.
2. Remove the mounting bracket attached to the back of the controller housing by pulling the lower edge of the bracket away and downward from the controller housing.
3. Place the mounting bracket (A) against the wall aligning the top edge at about eye level. Drive three 1" (25 mm) wood screws (B) into the wall through the three holes provided in the bracket.

Note: If you are installing the bracket on drywall or masonry, install screw anchors (C) to prevent screws from loosening.

4. **Optional** - Insert 3/4" (19 mm) PVC conduit (D) for valve wiring into bracket sleeve (E).
5. Align the slotted openings on the back of controller housing with the mounting bracket tabs. Slide the controller downward to engage the tabs.

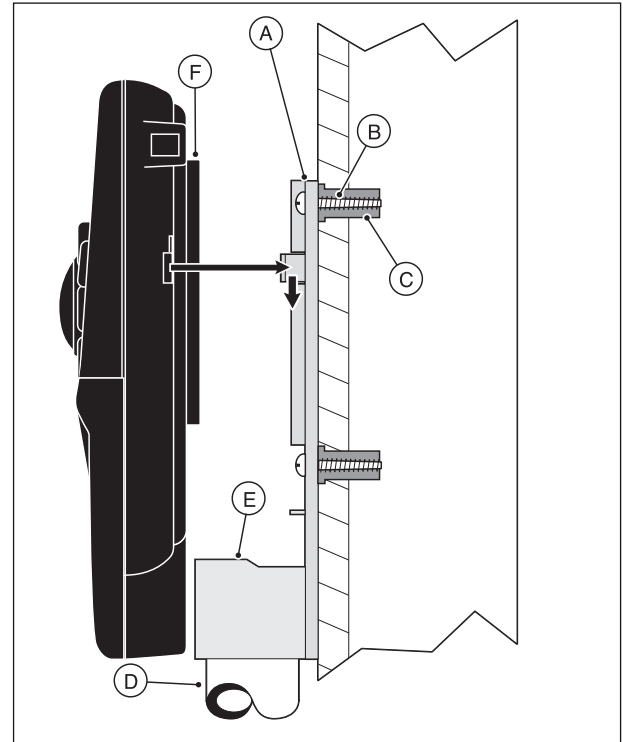

Note: After installation, store the Quick Reference Guide and the Watering Schedule Form in the pocket (F) behind the controller.

Connecting the Valves

Note: Using 14 to 18 AWG (2.5mm² to 1mm²) irrigation cable is recommended. This cable is made specifically for automatic irrigation systems and is available in several lengths and conductor count. Always use a cable that has at least one wire for each valve and one wire for the valve common connection.

1. Route the valve control wires between the valves and the controller.
2. Attach the white-color cable wire to one wire from each valve solenoid. (Either solenoid wire can be used for this connection.) This wire is referred to as the **valve common**.
3. Attach a separate cable wire to the remaining wire from each valve solenoid. Make a note of the wire color code used for each valve and the station it controls. You will need to have this information when connecting the wires to the controller.
4. Secure all wire splices using twist-on wire connectors. To prevent corrosion and possible short circuits, use a grease cap or similar waterproofing method to insulate each connection.
5. Route the wire cable into the controller through the large opening in the base of the housing or through PVC conduit if it is installed. Remove 1/2" (13mm) of insulation from the end of each wire.

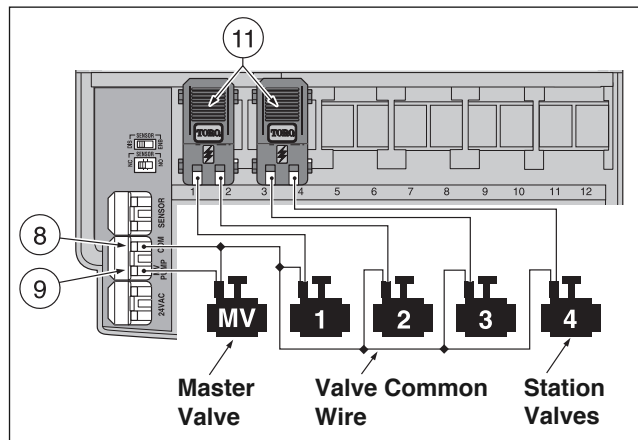

- Note:** The station module has snap-in wire connectors. To attach wires, simply raise the lever and insert the bare wire end into the small hole beneath the lever. Press the lever down to secure the wire. Pull lightly on the wire to confirm that it is locked into the module.
6. Referring to the Controller Components on page 5 and the diagram above, secure the valve common wire to the terminal labeled COM (8). Connect the individual station valve wires to the appropriate station module terminals (11). Connect the master valve control wire (if applicable) to the terminal labeled PUMP/MV (9).

Note: Connecting a master valve or pump start relay is optional and may not be required for your sprinkler system.

Connecting a Pump Start Relay

⚠ CAUTION: Never connect an auxiliary pump starter directly to the controller. A 24 VAC relay, rated at 0.50A maximum current draw, must be used to connect the controller to the pump starter circuit.

1. Route a wire pair from the pump start relay into the controller housing.
2. Connect one wire to the valve common COM (8). Connect the remaining wire to the PUMP/MV (9) as shown below.

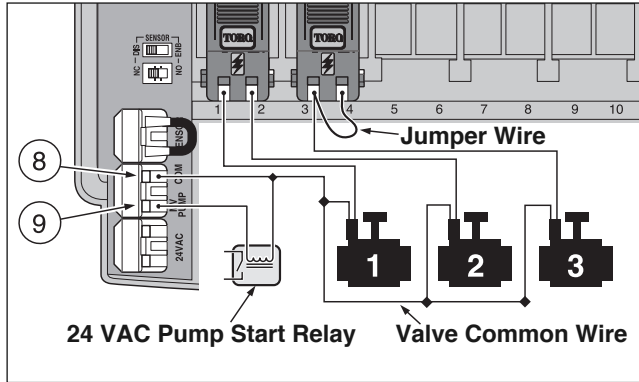

⚠ CAUTION: If the pump does not have an automatic pressure control switch, prevent pump damage due to “dead-heading,” by connecting a jumper wire from any unused station terminal to a station terminal with a valve wire connected.

Note: Refer to “Pump Control and Well Recovery” section on page 28 for important pump circuit control information.

Connecting the Plug-in Transformer

⚠ CAUTION: Do not plug the transformer into an electrical outlet until all of the wiring procedures have been completed.

1. Route the cable from the transformer (13) through the small opening provided in the base of the housing. Wrap the cable around and through the restraining post as shown below.
2. Connect one transformer cable wire to each terminal labeled 24 VAC (10). The wires can be connected to either terminal.

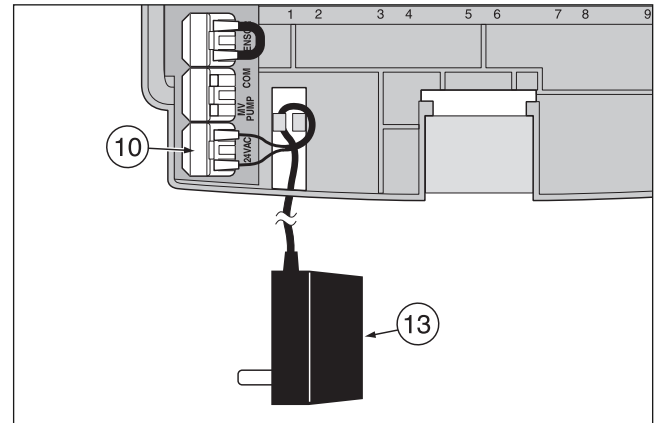

Note: The display will begin flashing 12:00 a.m. Press any button to stop the display from flashing.

Outdoor Model Installation

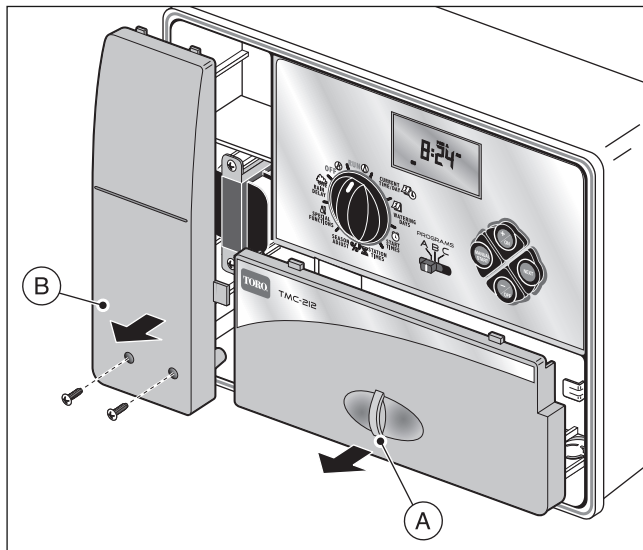

Preparing the Cabinet for Installation

1. Remove the lower housing cover (A) by pulling outward on the handle.
2. Remove two phillips screws from the transformer access cover (B). Pull the cover outward from the bottom to remove.
3. Three lower mounting holes (C) are provided. The center hole is open and the outer holes are plugged. If you intend to use the outer holes for installation, carefully drill through the plugs with a 3/16" (5mm) drill bit.

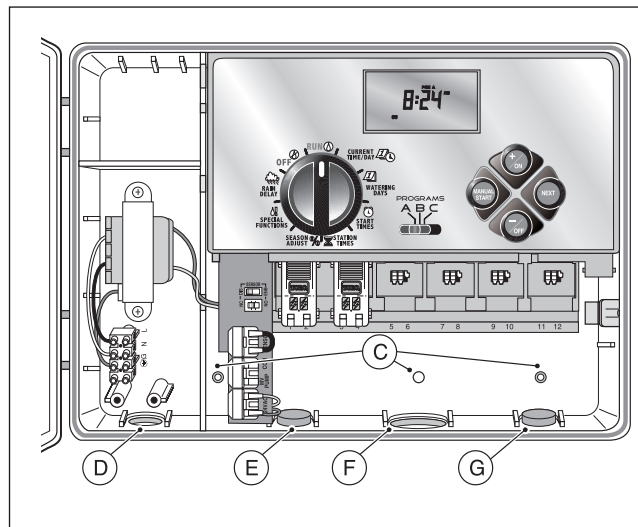

Four wiring access holes are provided in the cabinet base as follows:

- (D) - 1/2" (13mm) for power and equipment ground wires.
 - (E) - 1/2" (13mm) (plugged) for optional Toro Rain Sensor wires.
 - (F) - 3/4" (19mm) for sprinkler valve wires.
 - (G) - 1/2" (13mm) (plugged) for optional Toro remote control cable.
4. If planning to install the optional Toro components, remove the plugs as necessary.

Installing the Cabinet

1. For safe, reliable operation, select an installation site which will provide the following conditions:
 - Protection from irrigation spray, exposure to direct sun during the hottest hours, wind and snow.
 - Access to a grounded power source which is not controlled by a light switch or utilized by a high current load appliance, such as a refrigerator or air conditioner.
 - Access to the sprinkler control valve wiring and optional accessory wiring.
2. Drive a wood screw (provided) into the wall at eye level (A). Leave the screw extended approximately 1/4" (6.5 mm) from the wall.

Note: If you are installing the controller on drywall or masonry, install screw anchors to prevent screws from loosening. Use the dimension shown to predrill holes for screw anchors.

3. Hang the cabinet on the screw using the keyhole slot (B) on the back panel. Make sure the cabinet slides down securely on the screw.
4. Install the lower mounting screw(s) and tighten securely.

Note: Conduit and adapters are not provided. Install conduit as required by local electrical codes.

5. Install 1/2" (13 mm) conduit (C) for power/equipment ground wires and 3/4" (19 mm) conduit (D) for valve wires.

Note: After installation, store the User's Guide and Quick Reference Guide on the hook located on the inside of the door.

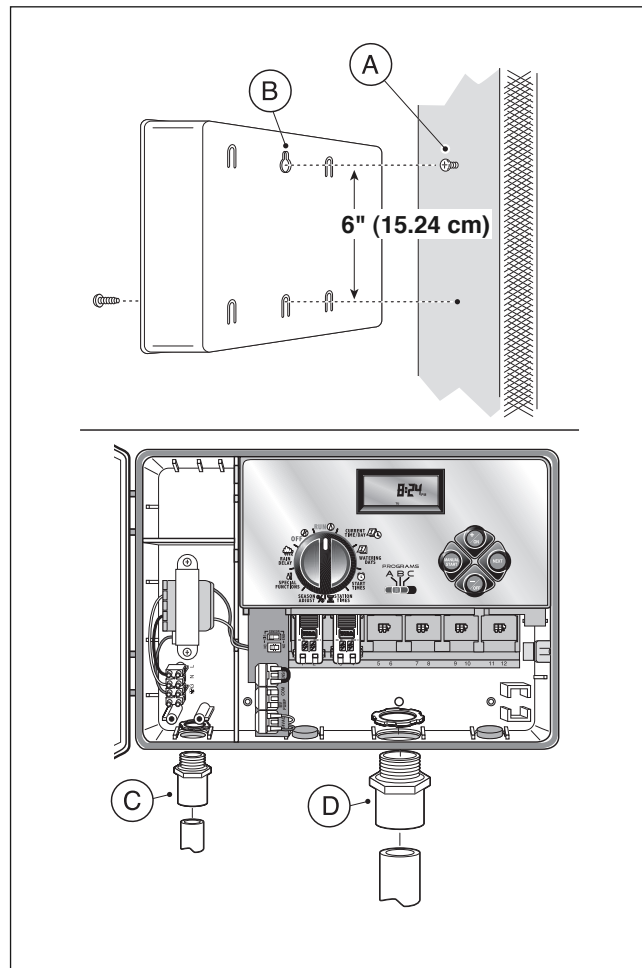

Connecting the Valves

Note: Using 14 to 18 AWG (2.5mm² to 1mm²) irrigation cable is recommended. This cable is made specifically for automatic irrigation systems and is available in several lengths and conductor count. Always use a cable that has at least one wire for each valve and one wire for the valve common connection.

1. Route the wire cable from the valve location into the controller cabinet.
2. Attach the white (preferably) cable wire to either wire from each valve solenoid. This is called the **valve common** wire.

Note: The solenoid does not have specific polarity, so either wire can be used for the common wire connection.

3. Connect an individual color-coded cable wire to the remaining solenoid wire of each valve. Make a note the wire insulation color used for each connection and the sprinkler zone controlled by the valve.

⚠ IMPORTANT: To prevent possible short-circuit conditions causing controller damage, properly connect, insulate and waterproof all wire splices.

4. Remove 1/2" (13mm) of insulation from the end of all cable wires to be connected to the controller.

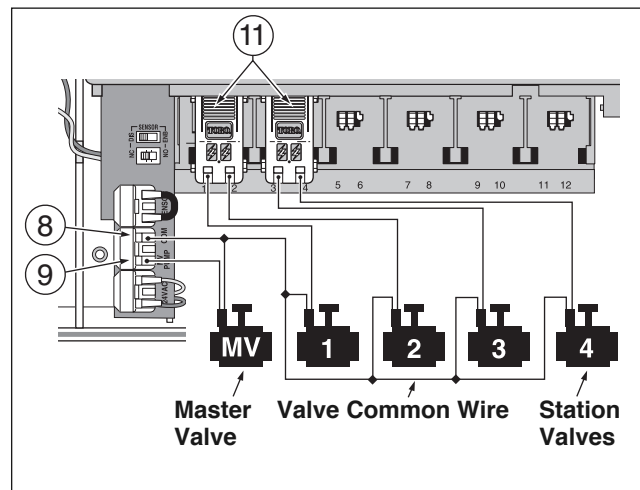

Note: The station module has snap-in wire connectors. To attach wires, simply raise the lever and insert the bare wire end into the small hole beneath the lever. Press the lever down to secure the wire. Pull lightly on the wire to confirm that it is locked into the module.

5. Referring to the Controller Components on page 5 and the diagram above, secure the valve common wire to the terminal labeled COM (8). Connect the individual valve wires to the appropriate expansion module terminals (11). The stations are numbered from left to right, 1 through 12. Connect the master valve wire (if applicable) to the terminal labeled PUMP/MV (9).

Connecting a Pump Start Relay

⚠ CAUTION: To prevent controller damage, never connect an auxiliary pump starter directly to the controller's 24 VAC output. A 24 VAC 0.50A relay, must be used to connect the controller to the pump starter circuit.

1. Route a wire pair from the pump relay into the controller housing.
2. Connect one wire to the terminal labeled COM (8). Connect the remaining wire to the terminal labeled PUMP/MV (9) as shown below.

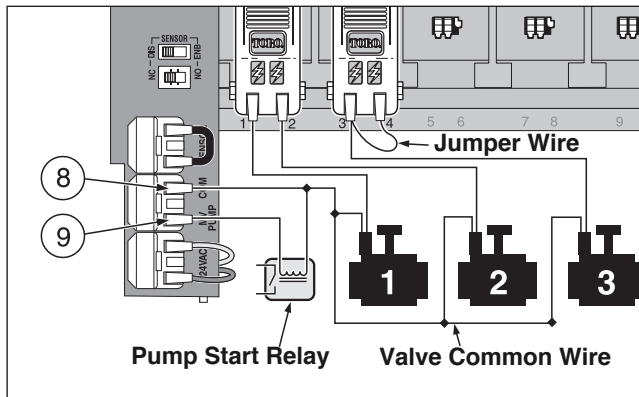

⚠ CAUTION: To prevent pump damage due to prolonged dead-head pressure, connect a jumper wire from an unused station terminal to a terminal with a valve connected.

Note: Refer to "Pump Control and Well Recovery" section on page 28 for important pump circuit control information.

Connecting the Power Source

⚠ WARNING

AC power wiring must be installed and connected by qualified personnel only. All electrical components and installation procedures must comply with all applicable local and national electrical codes. Some codes may require a means of disconnection from the AC power source installed in the fixed wiring and having a contact separation of at least 0.120" (3mm) in the line and neutral poles.

Make sure the power source is OFF prior to connecting the controller.

1. Route the power and equipment ground wires from the power source, through the conduit and into the controller transformer compartment.
Note: The controller terminal block accepts wire size up to 12 AWG (4 mm²).
2. Remove 3/8" (10 mm) insulation from the wire ends.
3. Using a small flat blade screwdriver, secure the wires as shown to the terminal block as follows:
Line or Line 1 (L1) to L, Neutral or Line 2 (L2) to N and Equipment Ground to ⓍG.
4. Install and secure the transformer compartment cover.
5. Apply power to the controller.

Note: The display will begin flashing 12:00 a.m. Press any button to stop the display from flashing.

Connecting the Power Source (cont.)

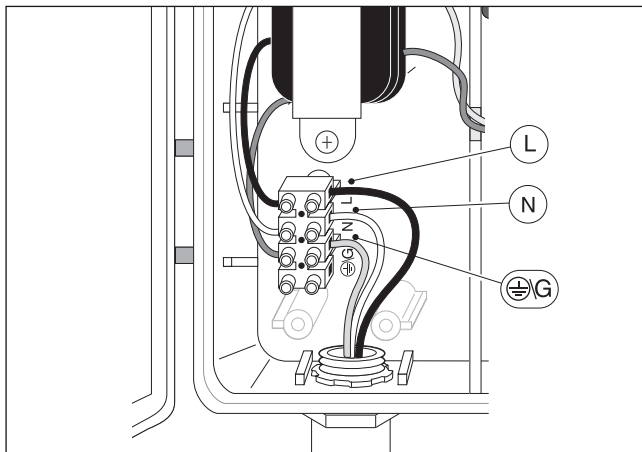

Connecting a Rain Sensor (optional)

A rain sensor is an optional control device that connects directly to the TMC-212 to automatically interrupt automatic controller operation during rain.

A sensor bypass switch is provided to enable sensor operation to be disabled as needed.

A sensor configuration switch enables the controller to work with a normally-open or normally-closed rain sensor.

When the rain sensor absorbs moisture it signals the TMC-212 to suspend automatic watering operations.

The No Watering  symbol is displayed until the sensor dries out and automatically resets.

When the No Watering  symbol disappears, controller operation will resume as programmed.

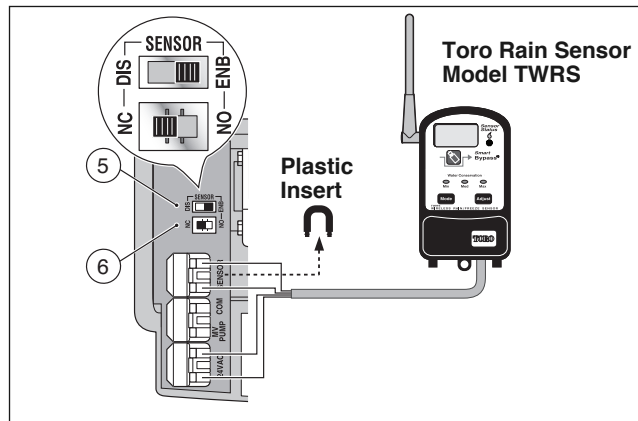

1. Route the sensor wires into the controller housing through the access hole provided.
2. Release the Sensor terminal connectors and remove the plastic u-shaped insert. Connect the sensor wires per the instructions provided with the sensor.
3. Set the Sensor configuration switch (6) to **NC** (Normally Closed) or **NO** (Normally Open) as required by the sensor type installed.

⚠ IMPORTANT: Do not use ENB and NC switch position simultaneously unless a Normally Closed rain sensor is connected. Watering operation will be suspended if this condition occurs.

4. Set the Sensor control switch (5) as required: **ENB** (enable) allows the rain sensor to interrupt watering; **DIS** (disable) bypasses the rain sensor input.
5. Refer to the instructions provided with the rain sensor for complete setup and operating information.

Getting Started – Irrigation System Basics

The three major components of every automatic sprinkler system are the controller, the control valves and the sprinklers/emitters.

The controller is the brain of the system, signaling each control valve when and how long to open. The valves are connected to expansion modules within the controller, and identified as Station 1, Station 2, etc. Each station controls a group of sprinklers in a specific portion of the landscape called a watering “Zone.” The zones are generally laid out according to the type of plant material being watered and the type and flow rate of the sprinklers used to distribute the water.

Automatic controller “Programs” are used to establish and organize different watering schedules. The TMC-212 provides three independent watering programs, designated **A**, **B** and **C**, and are established by specifying: what day(s) of the week to water – called **watering days**, what time to start watering – called **start time** and how long each station runs – called **station time**.

Each station can be assigned to each program and have a different amount of run time in each program.

When an automatic program starts, each station with an assigned run time in the program will operate one by one in numeric sequence, from lowest to highest station number.

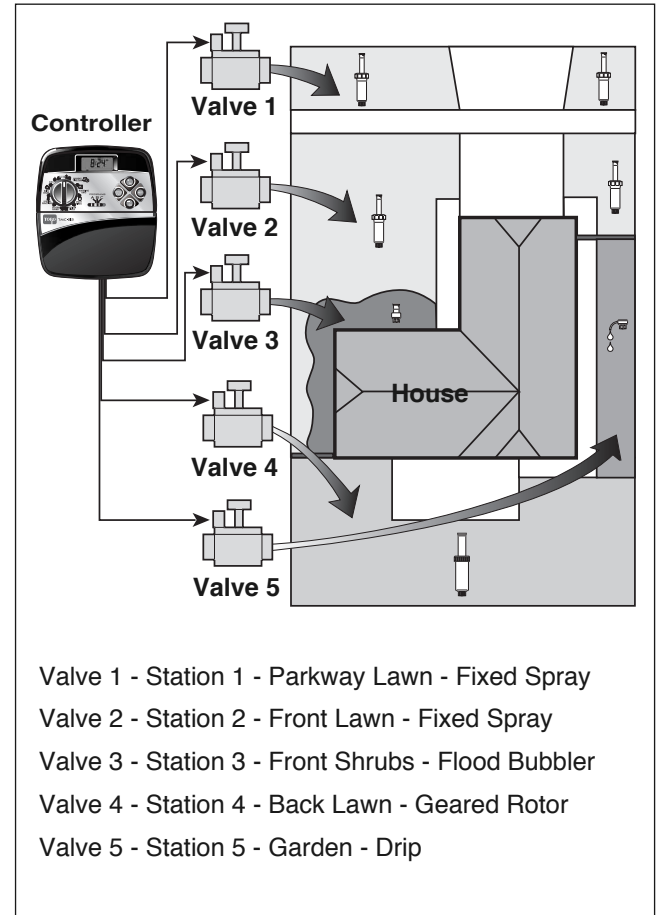

Watering Program Basics

The following example illustrates how a typical watering program could be set up for the sprinkler system shown on the previous page.

The diagram at the right depicts the watering program in a timeline format.

Example: The program start time is set for 3:00 a.m. Lawn stations 1 and 2 each have a run time of 10 minutes and lawn station 4 is set to run for 20 minutes. Note that stations 3 and 5 water shrubs and flowers and have been excluded from this program. (These stations will be set to operate on a separate program).

As shown in the watering program diagram, at 3:00 a.m. the controller starts the program watering cycle. Station 1 sprinklers run for 10 minutes and shut off. Next, station 2 sprinklers turn on, run for 10 minutes and shut off. The controller skips station 3, and turns on station 4 which runs for 20 minutes and shuts off. Station 5 is skipped and the watering cycle ends at 3:40 a.m.

As you can see from this example, only one program start time was needed to operate three different stations.

Using more than one program for example, would enable lawn zones to be watered every day on program **A**, shrub zones to run on on Monday, Wednesday and Friday on program **B** and drip irrigation to soak the flower beds every three days on program **C**.

Note: Although the TMC-212 offers the multiple program feature, you may want to use one program only if it meets your needs. The remaining programs can be turned off and on as you need to use them.

Watering Program Diagram

Program Starts

at 3:00 a.m.

Station 1

Station time

10 minutes

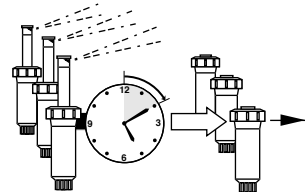

Station 2

Station time

10 minutes

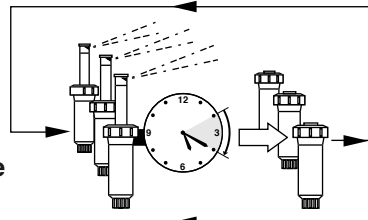

Station 4

Station time

20 minutes

Program Ends

at 3:40 a.m.

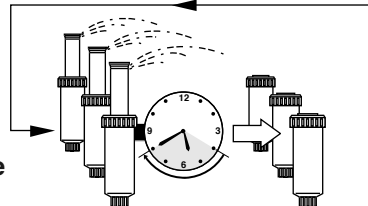

Watering Program Details

This section covers in detail each of the three parts of a watering program: watering days, program start times and station times.

Selecting a Watering Day Schedule

The TMC-212 provides three optional formats to schedule watering days: **Calendar**, **Interval** and **Odd/Even**.

The Calendar Format

The Calendar format is a recurring 7-day schedule that begins on Sunday and enables you to select specific days of the week to water.

This illustration shows how a Calendar schedule would be displayed when the control dial is in the **WATERING DAYS**  position.

In this example, program **A** has watering days set for Monday (**MO**), Wednesday (**WE**) and Friday (**FR**).

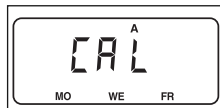

The Interval Format

The Interval format provides a periodic watering day schedule ranging from 1 (everyday) to 7 (every-7th day) in one-day increments. For example, to water every third day, you would select a 3-day interval.

Since the interval schedule is not tied to specific days of the week, you can determine when the interval schedule will start by selecting the initial watering day.

For example, if you have selected a 3-day Interval and today is Sunday, you may choose to have today, Monday or Tuesday be the first watering day of the interval. If you select Monday, the next watering day will be Thursday.

This illustration shows how an Interval schedule would be displayed. In this example, program **B** has a 3-day Interval schedule set to begin on Monday.

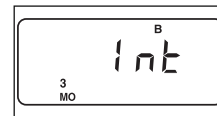

Odd or Even Day Format

The Odd or Even day format enables you to select all odd- or all even-numbered days of the month to water.

This illustration shows how an Odd day schedule for program **A** would be displayed.

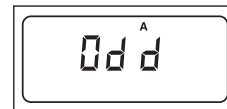

Day Exclusion Feature

Since the Interval and Odd/Even watering day formats are not tied to actual calendar days, the Day Exclusion feature enables you to exclude specific days of the week from the watering schedule. For example, due to water conservation restrictions, watering is not permitted on Monday. Also, the lawn is mowed on Saturday, so Monday and Saturday will be excluded from the schedule.

This example shows the days excluded (**dE**) are Monday and Saturday in watering program **A**.

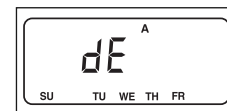

Program Off

Selecting Off disables the program until needed and does not alter or erase any of its current settings.

This illustration shows how a program would be displayed if it is turned Off. In this example, program **C** is Off.



Setting Program Start Times

A program **start time** is the time of day an automatic program watering cycle will start. The TMC-212 enables each watering program (**A**, **B** and **C**) to have four independent start times.

Please note the following start time conditions:

- A watering program requires only one start time to operate automatically.
- A start time is assigned to a watering program, not to an individual station.
- When a start time occurs, the stations with operating time assigned in the program will be operated one at a time (for their set duration) in numeric sequence.
- If a program start time occurs while the controller is already running a watering cycle, the start will be delayed until the current watering cycle concludes (known as “Stacking”).

Program start times are indicated by numbers **1–4** shown at the top of the display when the control dial is in the **START TIME**  position. Start time number 1 and its corresponding start time (or OFF) will begin flashing.

In this example, program **A** has two assigned start times. Start time **1** is set for 1:00 a.m. and start time **2** is set for 5 a.m. Start times **3** and **4** are currently not used. Only start time numbers with an assigned start time will be displayed.

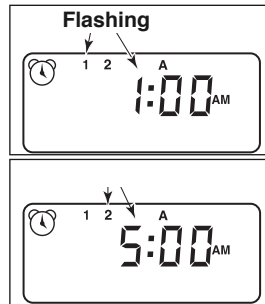



Setting the Station Run Time

Station run time is the length of time a station valve stays open during a watering cycle. Station run time can be set from 1 minute to 4 hours (in 1-minute increments).

When setting a station run time, the first step is to select a watering program. When a station is given a run time of at least 1 minute, it is **assigned** to the program. A station is removed from a program by setting its run time to “Off.”

Each station can have a different length of run time assigned in each program. For example, station 1 could have a 15-minute run time in program **A**, a 10-minute run time in program **B** and no run time (Off) in program **C**.

All stations assigned to the selected program are displayed below the run time symbol  position when the control dial is turned to the **STATION TIMES**  position.

The station number and its corresponding run time (or OFF) will begin flashing when selected.

In this example, the stations with an assigned run time in program **A** are shown. Station 1 has a 10-minute run time, Station 2 is set for 12 minutes and Station 4 is set to water for 20 minutes. Stations 3, 5 and 6 do not have an assigned run time in program **A** and are not shown.

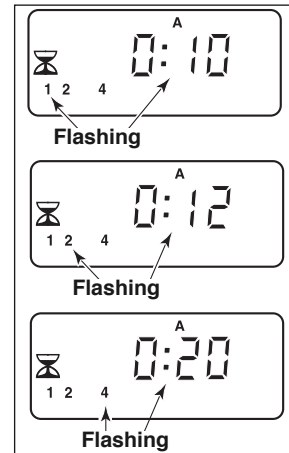

Planning Your Watering Schedule

It is generally helpful to organize your initial watering schedule on paper before beginning the programming steps. The information can be recorded on the Watering Scheduling form located inside the cover of the outdoor controller or on the blank form provided on page 20.

Guidelines for Watering

There are several factors to be considered when determining how much to water. For example, the soil composition, the type of lawn and plants, exposure to sun and shade and the rate at which the sprinklers apply water. Because of these variables, an exact schedule can not be provided. Some trial and error will be required to find the best watering schedule, but here are some general watering guidelines to help you get started.

- Water two or three hours before sunrise. You will have the best water pressure at this time and evaporation will be minimal.
- With a new lawn, water frequently for a short duration to keep the soil and plants moist at all times until established. Cut back on watering if runoff occurs.
- With an established landscape, water enough to saturate the plants and soil without causing runoff. Gradually cut back watering over a period of time until you notice signs of plant stress. Increase watering gradually just enough to regain plant health and vitality. This watering method enables a healthy landscape to be maintained using the least amount of water.

Filling Out the Watering Schedule Form

- **Location** - Identify the portion of the landscape watered by each station.
Note: Enter the following information for each program (**A**, **B** and **C**). If a program is not needed, leave its information column blank.
- **Watering Day Schedule** - For a Calendar schedule, circle the day(s) of the week that watering is desired. For an Interval schedule, circle the desired Interval number. For Odd or Even days, simply mark the appropriate box. If you need to restrict watering on certain days, circle the excluded day(s).
- **Station Time** - Indicate the amount of run time (1 minute to 4 hours) for each station. Write "Off" for any station that you do not want to assign to the program.
- **Well Recovery Delay Time** - See "Setting Pump Start/Master Valve and Well Recovery Controls" on pages 28–30 and 38–39 for detailed information.
- **Program Start Times** - Indicate the time(s) of day to start the program. Each program can have up to four assigned start times.
Note: The TMC-212 runs one program watering cycle at a time. Within the cycle, only one station runs at a time. Therefore, when scheduling multiple programs and/or multiple start times per program, make sure that each program watering cycle can run to completion before the next program cycle is scheduled to start. A program that attempts to start during an active watering cycle will be delayed until the active watering cycle ends. If the program is delayed past Midnight, it will be canceled if the day is restricted from watering or is not a scheduled watering day.

(Example)

Watering Schedule Form		PROGRAM A								PROGRAM B								PROGRAM C								
WATERING DAY SCHEDULE	CALENDAR	SU	MO	TU	WE	TH	FR	SA	SU	MO	TU	WE	TH	FR	SA	SU	MO	TU	WE	TH	FR	SA				
	INTERVAL	1	2	3	4	5	6	7	1	2	3	4	5	6	7	1	2	3	4	5	6	7				
	ODD/EVEN	ODD <input checked="" type="checkbox"/>				EVEN <input type="checkbox"/>				ODD <input type="checkbox"/>				EVEN <input type="checkbox"/>				ODD <input type="checkbox"/>				EVEN <input type="checkbox"/>				
	EXCLUDE	SU	MO	TU	WE	TH	FR	SA	SU	MO	TU	WE	TH	FR	SA	SU	MO	TU	WE	TH	FR	SA				
STATION	LOCATION	STATION RUN TIME								STATION RUN TIME								STATION RUN TIME								
1	Parkway Lawn	10								Off								Off								
2	Front Lawn	10								Off								Off								
3	Front Shrubs	Off								20								Off								
4	Back Lawn	25								Off								Off								
5	Garden	Off								Off								1 hr								
6																										
7																										
8																										
9																										
10																										
11																										
12																										
WELL RECOVERY DELAY TIME		10 minutes																								
PROGRAM START TIMES		1	2:30 am								4:00 am								5:00 am							
		2	Off								Off								Off							
		3	Off								Off								Off							
		4	Off								Off								Off							

Watering Schedule Form		PROGRAM A							PROGRAM B							PROGRAM C							
WATERING DAY SCHEDULE	CALENDAR	SU	MO	TU	WE	TH	FR	SA	SU	MO	TU	WE	TH	FR	SA	SU	MO	TU	WE	TH	FR	SA	
	INTERVAL	1	2	3	4	5	6	7	1	2	3	4	5	6	7	1	2	3	4	5	6	7	
	ODD/EVEN	ODD <input type="checkbox"/>			EVEN <input type="checkbox"/>				ODD <input type="checkbox"/>			EVEN <input type="checkbox"/>				ODD <input type="checkbox"/>			EVEN <input type="checkbox"/>				
	EXCLUDE	SU	MO	TU	WE	TH	FR	SA	SU	MO	TU	WE	TH	FR	SA	SU	MO	TU	WE	TH	FR	SA	
STATION	LOCATION	STATION RUN TIME							STATION RUN TIME							STATION RUN TIME							
1																							
2																							
3																							
4																							
5																							
6																							
7																							
8																							
9																							
10																							
11																							
12																							
WELL RECOVERY DELAY TIME																							
PROGRAM START TIMES		1																					
		2																					
		3																					
		4																					

Programming the Controller

About the Watering Program Memory

Once programmed, the TMC-212 memory will be retained for several years without power. Only the current time and date information will be lost and will need to be reset if power is interrupted from the controller for more than 24 hours.

The TMC-212 has a default watering program that will automatically control your sprinkler system when power is initially applied.

If you do not wish to program the controller, you can use the default settings. To enable the TMC-212 controller to operate Automatically in real time, just set the current time and date.

The default watering program settings are as follows:

- Program **A** has a Calendar watering schedule set to water every day. Programs **B** and **C** are turned Off.
- One program start time is set for 5:00 a.m.
- Station run time is set to 10 minutes per station.
- Pump Start/Master Valve circuit is On.
- Pump Start/Master Valve circuit delay is two seconds.
- Well Recovery time is 0 seconds.
- Pump Start/Master Valve circuit is enabled during Well Recovery time.
- Season Adjust is 100% (neutral).

Note: The controller's programmable memory can be reset to the default settings at any time. See "Clearing the Program Memory" on page 36 for detailed information.

Setting the Current Time and Date

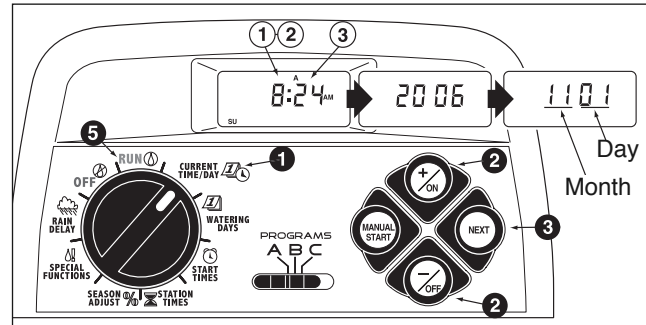

- 1 Turn the control dial to the **CURRENT TIME/DAY** position (the hour digits will begin flashing).

Note: The time of day will be displayed in hours and minutes (12-hour format). To select a 24-hour format, press the **NEXT** button repeatedly to display **12 H**. Press the **+ON** button to display **24 H**. Press the **NEXT** button once (the hour digits will begin flashing).

- 2 To increase the display value, press the **+ON** button; to decrease, press the **-OFF** button.

Note: The display characters will change rapidly when holding the **+ON** or **-OFF** button down for more than 7 consecutive seconds.

- 3 Press the **NEXT** button to select the next portion of the display.
4. Repeat steps 2 and 3 to set the following to set the current **minutes, year, month and day**.
- 5 When the current time and day are displayed, return the control dial to the **RUN** position.

Setting the Watering Day Schedule

Each program can have its own Calendar, Interval, Odd or Even schedule, but only one schedule can be active at a time for that program. The watering day schedule or OFF shown in the display when the control dial is in the **WATERING DAYS**  position will be the active schedule for that program.

- To set a Calendar schedule, continue below.
- To set an Interval schedule, continue on page 23.
- To set an Odd or Even schedule, continue on page 24.
- To turn a program Off, refer to page 26.

Setting a Calendar Schedule

- 1 - Turn the control dial to the **WATERING DAYS**  position.
- 2 - Check the **PROGRAMS** switch setting. If necessary, reposition the switch to select the desired program.
- 3 - The current watering schedule will be displayed. If **CAL** (Calendar) is not displayed, press the **+ / ON** or **- / OFF** button as needed to select **CAL**.
- 4 - Press the **NEXT** button. The watering days currently set for this program will be displayed; **SU** (Sunday) will begin flashing.
- 5 - To select Sunday as a watering day, press the **+ / ON** button. To remove Sunday from the schedule, press the **- / OFF** button; **MO** (Monday) will now begin flashing. Continue to select or remove each day of the week until only the desired watering days are shown.

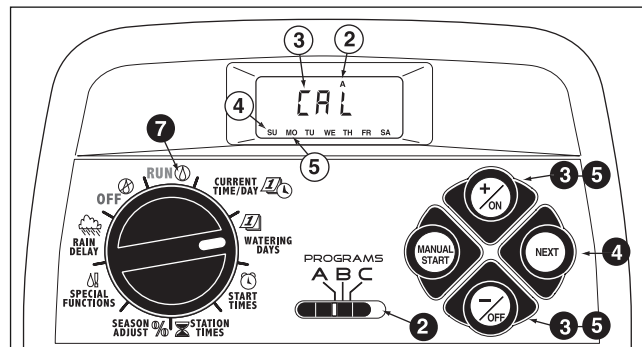

6. - To set a Calendar schedule for another program, return to step 2.
7. - When you have completed setting the Calendar schedule for each program (as needed) return the control dial to the **RUN**  position.

Setting an Odd or Even Schedule

- 1- Turn the control dial to the **WATERING DAYS**  position.
- 2- Check the **PROGRAMS** switch setting. If necessary, reposition the switch to select the desired program.
- 3- The current watering schedule will be displayed. If **Odd** or **Even** is not displayed, press the **+ / ON** or **- / OFF** button as needed to select **Odd** or **Even**.

Note: When **Odd** is selected, the 31st day of the month and February 29th of a leap year will not be active watering days.

- 4.- To set an Odd or Even schedule for another program, repeat steps 2 and 3 as needed.
- 5- When you have completed setting the **Odd** or **Even** schedule for each program as needed, return the control dial to the **RUN**  position.

Note: The Day Exclusion feature enables you to select any day(s) of the week to be excluded and remain off when using an Interval or Odd/Even watering schedule.

See page 25 for detailed information.

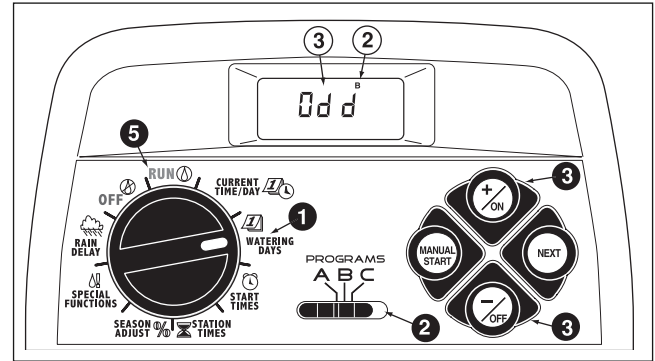

Using the Day Exclusion Feature

A Calendar schedule is generally used to exclude or select specific days of the week for watering. However, if an **Interval** or **Odd/Even** watering schedule is preferred (or required), the Day Exclusion feature enables you to select any day(s) of the week to be excluded and remain off regardless of the program schedule.

Note: The selected program must have an **Interval** or **Odd/Even** watering schedule to use the Day Exclusion feature.

- 1 Turn the control dial to the **WATERING DAYS**  position.
- 2 Check the **PROGRAMS** switch setting. If necessary, reposition the switch to select the desired program.
- 3 The current watering schedule (Interval or Odd/Even) will be displayed. Press the **NEXT** button as needed to display **dE** (flashing) and the days of the week.
- 4 Press the **NEXT** button again. **SU** (Sunday) is selected and will begin flashing.
- 5 To **exclude** Sunday from the watering schedule, press the **-/OFF** button; **SU** will be removed from the display. To keep Sunday in the program schedule, press the **+ /ON** button; the next day in sequence will be selected. Repeat this procedure for each day of the program schedule.

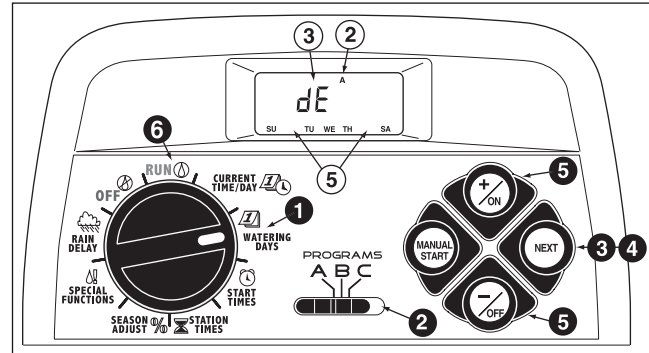



Example: Monday and Friday have been excluded from program **A**.

- 6 When finished, return the control dial to the **RUN**  position.

Turning Off a Program

Note: Turning off a program does not alter or erase a preset watering day schedule. Selecting **Off** simply places the program on hold until one of the watering day schedules is selected.

- 1 - Turn the control dial to the **WATERING DAYS**  position.
- 2 - Check the **PROGRAMS** switch setting. If necessary, reposition the switch to select the desired program.
- 3 - Press the **+ / ON** or **- / OFF** button until **OFF** is flashing.
- 4 - To turn off another program, repeat steps 2 and 3 as needed.
- 5 - Return the control dial to the **RUN**  position.

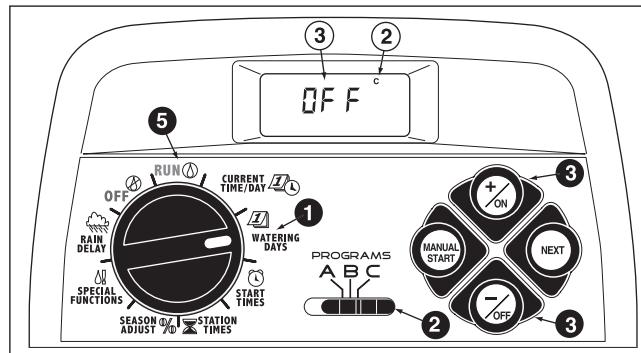

Setting Program Start Times

A program **start time** is the time of day that an automatic watering cycle will start. The TMC-212 enables you to assign up to four automatic start times per program.

- 1 Turn the control dial to the **START TIMES** ⌚ position. Start times are designated by numbers 1–4 shown at the top of the display.
- 2 Check the **PROGRAMS** switch setting. Position the switch as necessary to select the desired program.
3. Start time number 1 and its current setting are selected (flashing). To adjust start time number 1, continue at step 5.

Note: To enable a start time to be set or changed, it must be flashing.

- 4 To set or adjust start time number 2, 3 or 4, press the **NEXT** button as needed to select the number.
- 5 Press the **+ / ON** button to increase or **- / OFF** button to decrease the displayed time. To change the display rapidly, press and hold the button for more than 7 consecutive seconds.

Note: When using the 12-hour clock format, make sure the desired **AM / PM** designator is displayed.

Note: To quickly remove a start time, press the **+ / ON** and **- / OFF** buttons **at the same time** until **OFF** is displayed.

6. To set or adjust additional start times for this program, repeat the procedure beginning at step 4.

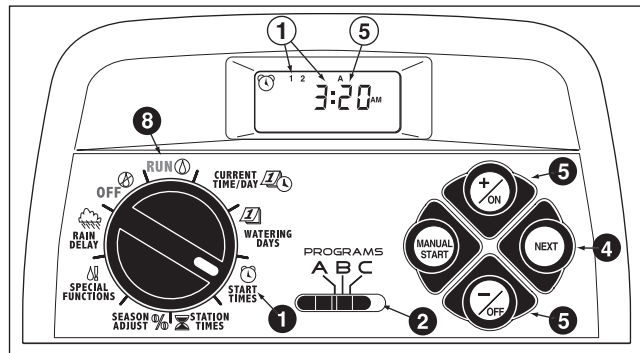

7. To set or adjust start time(s) for another program, repeat the procedure beginning at step 2.
- 8 When finished, turn the control dial back to the **RUN** ⌚ position.

Setting Station Run Times

Station run time determines how long the station will operate during a program watering cycle. Each station can have a different run time assignment in each program. Run time is adjustable from OFF to 4 hours, in 1-minute increments.

- 1- Turn the control dial to the **STATION TIMES** ⌚ position. All station numbers with a run time set in the selected program will be shown at the bottom of the display.
- 2- Check the **PROGRAMS** switch setting. Position the switch as necessary to select the desired program.
- 3- Station 1 and its current run time (or OFF) will be flashing. To adjust the run time, continue at step 5.
- 4- To select a different station number, press the **NEXT** button.
- 5- Press the **+ / ON** button to increase or **- / OFF** button to decrease the time display.
Note: To change the display rapidly, press and hold the button for more than 7 consecutive seconds. To quickly reset the start time to Off, press the **+ / on and - / OFF** buttons **at the same time** until **OFF** is displayed.
- 6- To set station run times for another program, repeat the procedure starting at step 2.
- 7- When finished, turn the control dial back to the **RUN** ⏸ position.

Note: Basic programming is now complete. For optional Pump Start/Master Valve control setup procedures, continue at “Setting Pump Start/Master Valve.”

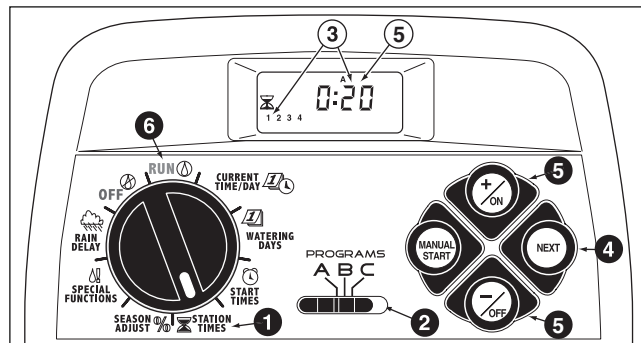

Setting Pump Start/Master Valve Control

The following procedures enable you to select and set the Pump Start/Master Valve (PS/MV) control options for each watering program. (Default shown in parenthesis.)

• PS/MV Master Switch (On)

Enables the PS/MV circuit to be switched On or Off for each program.

• PS/MV Pre-start (2 Seconds)

The PS/MV circuit is switched on prior to the first station in a watering cycle enabling a pump or master valve to be fully operational before watering begins. Adjustable from 2 to 60 seconds in 1-second increments.

• Well Recovery Delay (0 Seconds)

This feature enables a timed delay period to be placed between consecutive watering stations to facilitate well or reservoir recovery during a watering cycle.

• PS/MV Operation During Well Recovery (Yes)

This feature enables the PS/MV circuit to be switched On or Off during a Well Recovery delay period.

Note: For information regarding the practical application of the PS/MV control features, refer to the examples provided on pages 38 and 39.

- ❶ Turn the control dial to the **SPECIAL FUNCTIONS !** position. See **Example 1**.
- ❷ Check the **PROGRAMS** switch setting. If necessary, reposition the switch to select the desired program.

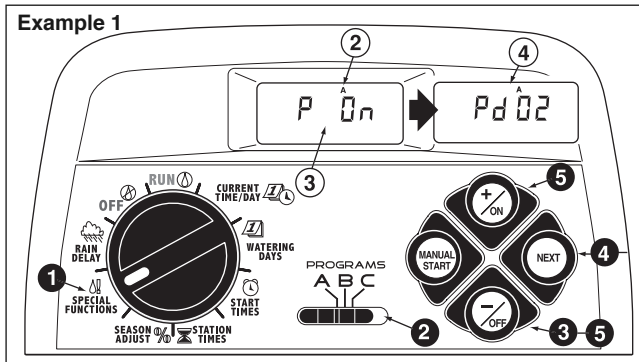

- ❸ The display will be flashing **P On** (Pump On). To toggle PS/MV circuit operation Off for this program, press the **-/OFF** button to display **P OFF** (Pump Off).
- ❹ Press the **NEXT** button to display the Pump Delay feature. **Pd 02** (Pump Delay - 2 seconds) will be displayed.
- ❺ To change the delay period, press the **+/ON** or **-/OFF** button to select 2 to 60 seconds .

- ❻ Press the **NEXT** button to display the Well Recovery delay period. Well Recovery symbol  and **S 00** (0 seconds) will be displayed. See **Example 2**.

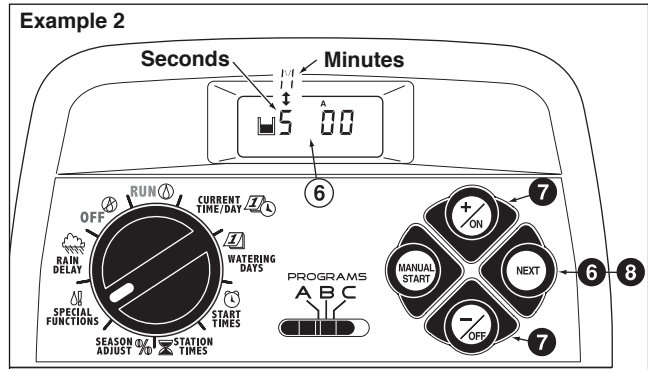

- ❼ To select a Well Recovery delay period from 1 to 60 seconds or 1 to 60 minutes, press the **+/ON** or **-/OFF** button. The display will change from **S** (Seconds) to **M** (Minutes) as the displayed time is increased past 59 seconds.

Note: The Well Recovery  symbol will remain displayed as a reminder that a delay time is set.

- ❽ Press the **NEXT** button to display the Pump Enable option. **PE Y** (Pump Enable-Yes) will be displayed by default.

Note: If the PS/MV circuit is enabled during a Well Recovery delay period, it will operate during the delay period between stations and turn off with the last operating station in the program.

(Continued on page 30.)

- 9 - To toggle the Pump Enable option Off for this program, press the **-OFF** button to display **PE n** (Pump Enable no). See **Example 3**.

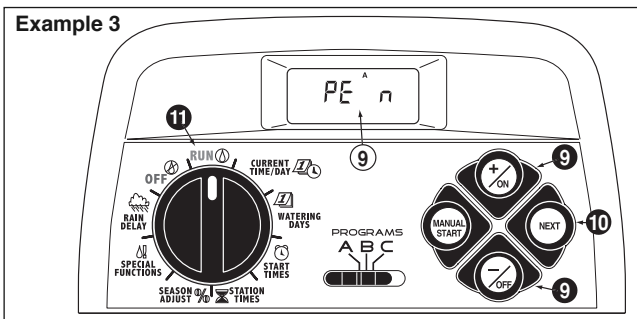

- 10 - To apply the PS/MV circuit control features to another program, press the **NEXT** button once, then repeat steps 2 through 9.
- 11 - When finished, return the control dial to the **RUN** position.

Controller Operation

The TMC-212 controller has three modes of operation: **Automatic**, **Manual** and **Off**.

- **Automatic mode** – The controller tracks the current time and day and automatically runs a watering program when a scheduled start time occurs.
- **Manual mode** – Automatic watering programs or select stations can be manually operated at any time.
- **Off mode** – Shuts off and prevents all watering activity.

Automatic Mode

In the Automatic mode, the TMC-212 keeps track of the current time, day of the week and the automatic watering program schedule. Automatic operation will occur whenever a programmed watering day and a start time match the current time and day.

The Automatic mode is selected when the control dial is in the **RUN** position. While in the automatic mode, the display will show two types of information: **Status** and **Operating**.

This example shows the **Status** display. The current time is 2:45 p.m. and the current day is Monday. Programs **A** and **B** are scheduled to operate today and a Well Recovery delay is set.



When watering starts, the **Operating** display appears with the Watering On symbol and indicates the current controller watering activity.

In this example, program **A** is currently operating. Station 1 has 10 minutes of run time remaining; stations 2 and 3 are also scheduled operate during this watering cycle.

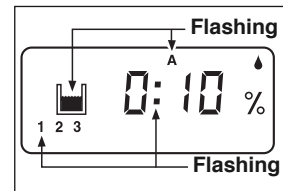

A Well Recovery delay period will occur between station operations. Program **A** also has a season adjust factor in use, indicated by the **%** symbol.

Note: If the control dial remains in any position except **OFF** for more than 8 minutes, the controller will revert to the Automatic mode and Status display.

Note: The position of the **PROGRAMS** switch does not determine which program will run during automatic controller operation. In other words, if a program has an assigned watering day schedule, start time and a station with run time, it will operate automatically regardless of the position of the **PROGRAMS** switch.

Manual Mode

Manual mode enables automatic watering programs and their assigned stations to be operated at any time.

Note: Once watering has started, refer to page 32 for additional manual control operations.

Note: Upon completion of a Manual mode operation, the controller will return to the Automatic mode.

Operate Watering Program(s)

- 1 Confirm that the control dial is in the **RUN** Ⓜ position.
- 2 Position the **PROGRAMS** switch to select a program.
- 3 Press the **MANUAL START** button two times to start the program watering cycle. The first active station number and the Watering On Ⓜ symbol will begin flashing.
4. To select additional programs, repeat steps 2 and 3.

Note: Additional programs are stacked (staged to run sequentially) in the order they are selected. The watering program identifier (**A**, **B** or **C**) will be displayed as each program is selected. The program currently operating is indicated by the flashing program identifier. As one program finishes, the next program in the stacked sequence will start.

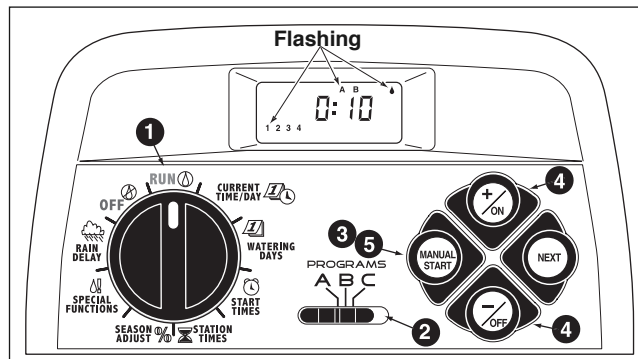

Operate Selected Stations

- 1 Confirm the control dial is in the **RUN** Ⓜ position.
- 2 Position the **PROGRAMS** switch to select a program.
- 3 Press the **MANUAL START** button one time.
- 4 The station numbers assigned to the program will be displayed. The first station number in sequence will begin flashing. To select the station(s) to operate, use the following procedure:
 - To select the station, press the **+ / ON** button.
 - To skip the station press the **- / OFF** button.
- 5 When the desired station numbers are displayed, press the **MANUAL START** button one time to start watering. The active station number and the Watering On Ⓜ symbol will begin flashing.

Watering Control Features

Once the sprinkler system is running, the following manual control features become available:

Pause Watering

To pause watering, press the **+ / ON** and **- / OFF** buttons **at the same time**.

- The station will temporarily turn off.
- The Watering On  symbol will begin flashing.
- The display will show the amount of station time remaining.



Note: If watering is not resumed within 8 minutes, all watering operations will be canceled and the controller will return to the Automatic mode.

To release Pause and resume operation, press the **NEXT** button.

- Watering activity will resume from the point of interruption.

Cancel Watering

Two methods of canceling current watering are available:

Method 1: Turn the control dial to the **OFF**  position, pause for two seconds, then turn the dial back to the **RUN**  position.

Method 2: Press the **+ / ON** and **- / OFF** buttons **at the same time – two times**.

Once canceled, all watering operations will be terminated and the controller will return to the Automatic mode.

Skip Stations

Press the **NEXT** button one time.

- The station currently watering will shut off and the next station will start.
- If the last station is skipped, the program will end. If additional programs have been set to operate, the next program in alphabetical order will start.

Adjust the Operating Station Run Time

To temporarily adjust the run time of the currently operating station:



Press the **+ / ON** button to increase run time, or the **- / OFF** button to decrease run time.

- If the run time is decreased to less than 1 minute, the station will shut off and the next station in sequence will begin watering.
- The adjusted run time is temporary and does not alter the station run time set for automatic watering program operation.

Rain Delay Feature



Note: Rain Delay and Season Adjust control features enable quick, temporary changes in operation to help compensate for changes in weather and season.

The Rain Delay feature enables all watering operations to be delayed from 1 to 7 days. For example, rain has been forecast in your area for the next two days. Instead of turning the controller Off (and possibly forgetting to turn it back on), a rain delay of 3 days can be easily entered. At the end of 3 days, the TMC-212 will resume automatic operation as scheduled.

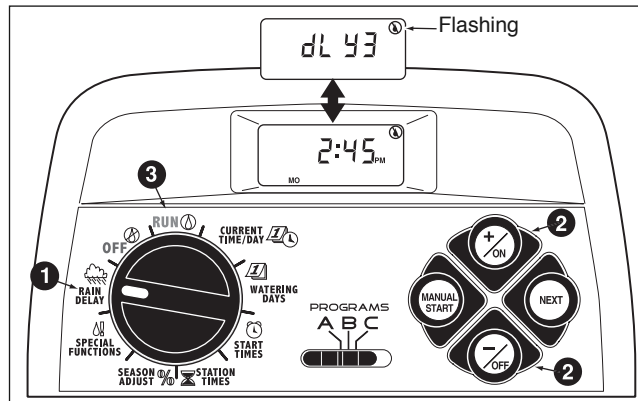
- 1 Turn the control dial to the **RAIN DELAY**  position. The rain delay display will begin alternating with the automatic status display.
- 2 To set the number of rain delay days, press the **+ / ON** or **- / OFF** button until the desired number (1–7) is flashing.
- 3 Return the control dial to the **RUN**  position.



Note: The rain delay number will automatically decrease by one digit each day. When the delay number counts down to 0, automatic watering operation will resume at the next scheduled start time.

To cancel the rain delay at any time, turn the control dial to the **OFF**  position. Leave the dial in the Off position for approximately five seconds, then return it to the **RUN**  position.

Season Adjust % Feature

Note: The Season Adjust % and Rain Delay features modify controller operation only and do not change the controller's programmable memory.

The Season Adjust % feature enables the station time of all stations (assigned to a watering program) to be simultaneously decreased or increased from 10–200% in 10% increments (100% equals no adjustment).

For example, setting Season Adjust to 50% decreases all stations to half of their programmed station time. A station programmed for 20 minutes would run 10 minutes and a station with 15 minutes would run 7 minutes and 30 seconds. As a conservation measure, an adjustment above 100%, first increases station run time, then splits the time in half. The program watering cycle then runs through twice consecutively. This method of increasing irrigation enables irrigation water to soak into the plant root zone instead of pooling and running off.

For example, adjusting to 150% will first increase a 20-minute station time to 30 minutes ($1.5 \times 20 = 30$). The controller automatically divides 30 minutes in half and runs the station for 15 minutes in back-to-back watering cycles.

Note: All station times are retained in the controller's programmable memory and returned to their set value when season adjust is reset to 100%. The adjusted station time will be displayed during operation.

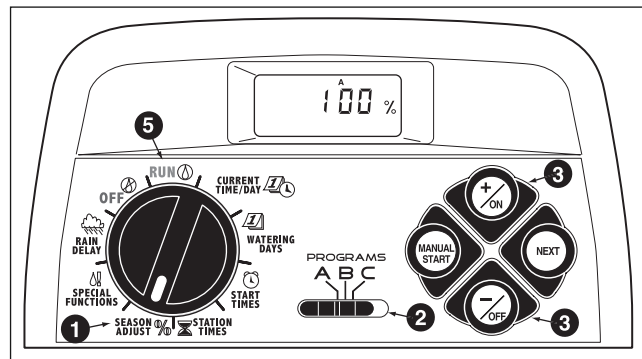

The % symbol will be displayed when an when the Season Adjust % feature is utilized.



- 1- Turn the control dial to the **SEASON ADJUST %** position. The season adjust display will be shown and 100% will be flashing.
- 2- Check the **PROGRAMS** switch setting. If necessary, reposition the switch to select the desired program.
- 3- Press the **+ / ON** or **- / OFF** until the desired adjustment value is flashing.
- 4- To apply the Season Adjust feature to another program, repeat steps 2 and 3.
- 5- Return the control dial the **RUN** position.

Note: The % symbol will be displayed in all dial positions as a reminder that this feature is in use.

Turn Off Controller Operation

When the control dial is turned to the **OFF**  position, controller operation stops immediately. Leaving the control dial in the **OFF**  position enables the controller maintain current time and day, while disabling automatic and manual watering activity.

- 1 Turn the control dial to the **OFF**  position.

The word **OFF** will be displayed for approximately eight minutes. The display will then revert to the automatic status display showing the current time and day.

For extended shutdown of the sprinkler system leave the control dial in the **OFF**  position.

- 2 To resume automatic or manual operation, turn the control dial to the **RUN**  position.

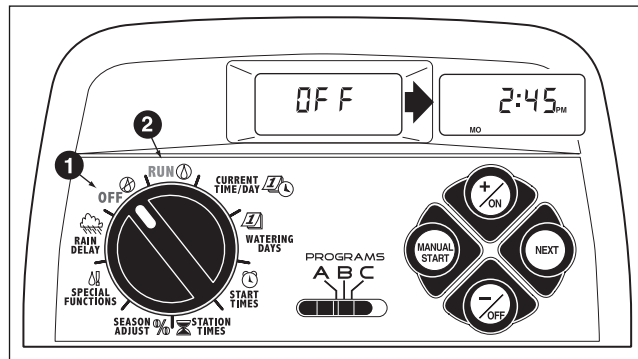

Appendix

Clearing the Program Memory

The user-defined watering program information stored in the TMC-212 memory will be retained for several years. If controller power is lost for more than 24 hours, only the time and date will need to be reset.

If for any reason you wish to clear the user-defined watering program information, two methods are provided:

- Clear and reset a selected program to default settings. (Default settings for Program A provide one daily automatic watering cycle.)
- Clear and reset all programs simultaneously to off. (All programs are turned off.)

⚠ IMPORTANT: These procedures permanently erase all user-defined program information that cannot be recovered once the procedure has been completed.

- To clear and reset memory of a selected program:

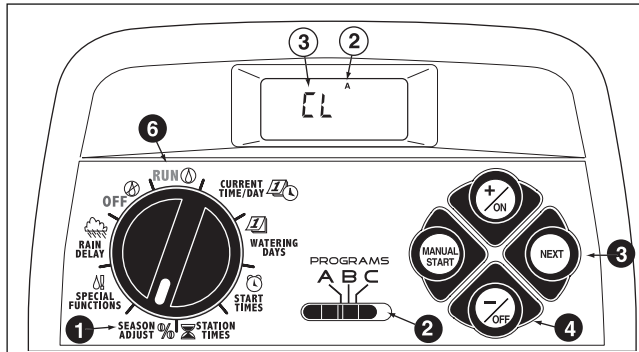

- 1 - Turn the control dial to **SEASON ADJUST %**.

- 2 - Position the **PROGRAMS** switch setting as necessary.
 - 3 - Press the **NEXT** button once; **CL** will be displayed and begin flashing.
 - 4 - Press and hold the **-/OFF** button until **CL** stops flashing (about five seconds). The memory will be cleared and reset to the factory default settings.
 - 5 - To clear the memory of another program, repeat all of the steps starting at step 2.
 - 6 - Return the control dial to the **RUN** position.
- To clear the memory of all programs:

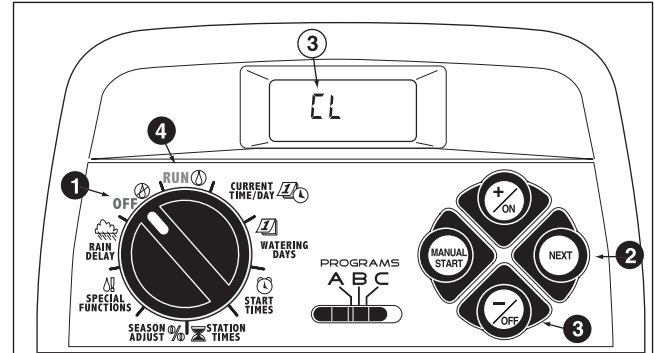

- 1 - Turn the control dial to the **OFF** position.
- 2 - Press the **NEXT** button to access the clear memory function; **CL** will be displayed and begin flashing.
- 3 - Press and hold the **-/OFF** button until **CL** stops flashing (approximately five seconds). All programs will be cleared simultaneously and turned OFF.
- 4 - Return the control dial to the **RUN** position.

About Automatic Circuit Protection

The TMC-212 features built-in circuit protection to help prevent damage to the controller caused by excessive current draw on the station and/or pump start/master valve circuits. This condition is generally caused by a shorted valve wire splice, faulty valve solenoid and/or pump start relay.

If the controller detects an overload condition on a station, it will bypass the affected station(s) during an automatic watering cycle. The word **“FUSE”** and the defective station number(s) will be displayed. All remaining stations will continue to operate as programmed.



If the overload condition occurs on the pump start/master valve circuit, the controller will immediately discontinue automatic operation and alternately display: **“FUSE - “MV.”**

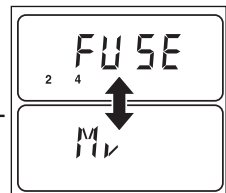

To clear the warning display, press the **-/OFF button.**

The controller will resume operation as scheduled and will attempt to run all stations as programmed.

⚠ IMPORTANT: Clearing the display does not correct the cause of the problem. The controller will continue to bypass the affected station(s) or discontinue operation until the overload condition is eliminated.

Before continuing to operate the controller, identify and resolve the cause of the problem. In most cases, this condition is caused by a faulty valve solenoid, pump start relay and/or a shorted wire splice.

Adding a 2-station Expansion Module

Note: Expansion modules are available in Standard-surge (TSM-02) and High-surge (TSM-02-H) versions. Although the TSM-02-H module can be used in any TMC-212 controller, it will only provide high (6.0 Kv) surge protection when installed in Outdoor controller models TMC-212-ODH and TMC-212-ODH-50H.

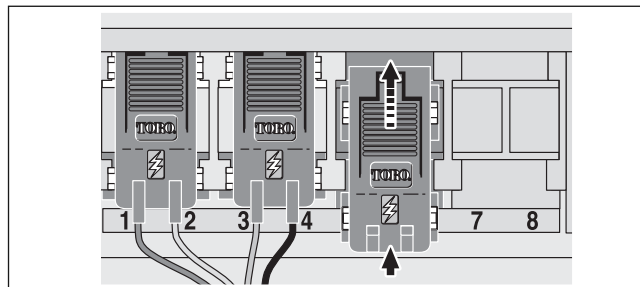

1. Turn the control dial to the **OFF**  position.
2. Remove the access cover.
3. Place the back of the station module squarely between the guides of the first open expansion slot (from left to right). Pushing lightly on the bottom of the module, slide it upward until it locks into position.
4. To connect the valve wires, refer to “Connecting The Valves” on page 7.
5. Reinstall the access cover.
6. To set the station time, refer to “Setting Station Times” on page 28.
7. To test the operation of the added station(s), refer to “Manual Mode” on page 31.

Using Pump Start/Master Valve and Well Recovery Controls

The following examples illustrate various practical application of automatic Pump Start/Master Valve (PS/MV) and Well Recovery timing controls and how they affect the program watering cycles

Example 1: The irrigation supply is pumped directly from a well.

Program Setup:

- Watering program start time: 3:00 a.m.
- Assigned Stations: 1, 2 and 3 each with a 20-minute station run time.
- PS/MV circuit: On (**P On**).
- PS/MV circuit delay: 60 seconds (**Pd 60**).
- Well Recovery time: 0 seconds (**S 00**).
- PS/MV circuit enabled during well recovery: No (**PE n**).



Example 2: Well water is pumped into a holding tank where it is gravity fed to the irrigation supply.

Program Setup:

- Watering program start time: 3:00 a.m.
- Assigned Stations: 1, 2 and 3 each with a 20-minute station run time.
- PS/MV circuit: On (**P On**).
- PS/MV circuit delay: 2 seconds (**Pd 02**).
- Well Recovery time: 15 minutes (**M 15**). (*See **Note** below.)
- PS/MV circuit enabled during well recovery: Yes (**PE Y**). (*See **Note** below.)

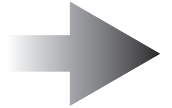

Example 3: The irrigation supply is pumped from a reservoir fed by a self-contained well water system.

Program Setup:

- Watering program start time: 3:00 a.m.
- Assigned Stations: 1, 2 and 3 each with a 20-minute station run time.
- PS/MV circuit: On (**P On**).
- PS/MV circuit delay: 2 seconds (**Pd 02**).
- Well Recovery time: 15 minutes (**M 15**). (*See **Note** below.)
- PS/MV circuit enabled during well recovery: No (**PE n**).

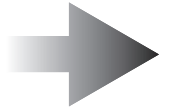

***Note:** When multiple watering programs are scheduled to operate immediately after one another (i.e., stacked), the Well Recovery time and PS/MV circuit (when enabled), will be operative between consecutive programs.

Example 1

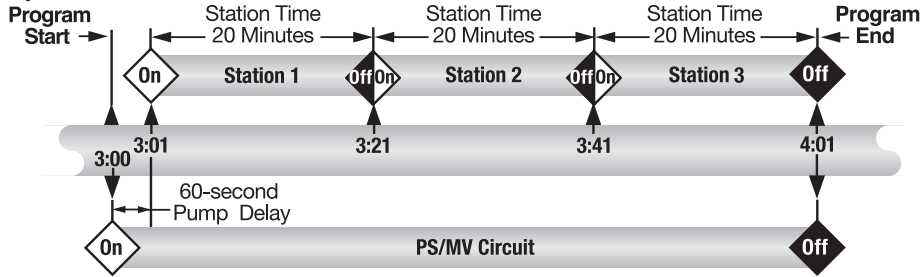

Example 2

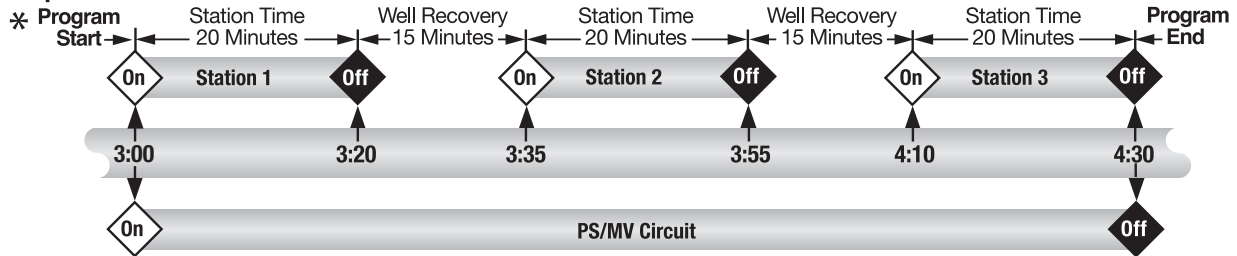

Example 3

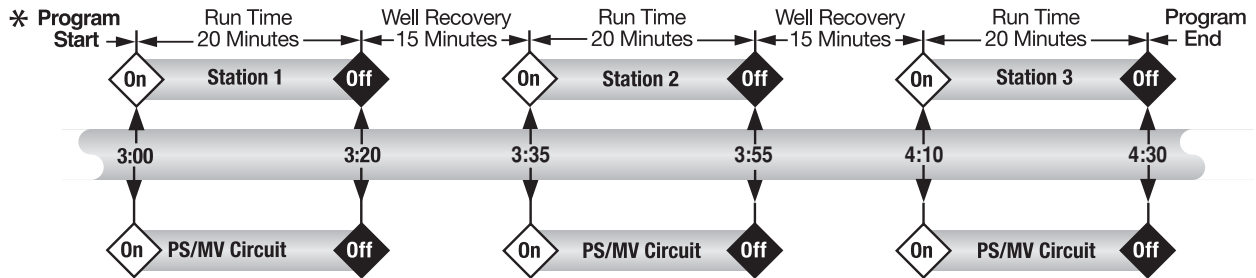

Troubleshooting

If you are having a problem with the controller, check the following symptoms, possible causes and remedies. If the problem can not be resolved or you would like assistance with any Toro irrigation product, call 1-800-664-4740 or 1-951-688-9221 (outside U.S.) Monday through Friday, 7:30 a.m – 4:00 p.m. (Pacific Standard Time).

Symptom	Possible Cause	Remedy
The display is blank and the controller does not operate.	Main power is disconnected.	Check the transformer connections (indoor model) or circuit breaker at service panel (outdoor model).
Watering programs start at unscheduled times.	Watering programs have overlapping start times (stacked).	Reduce station times. Change/remove program start times. (See p. 27).
A station does not turn on.	Faulty wire connection at station module. Shorted valve wire connection or faulty solenoid. Electronic Fuse has disabled station operation.	Remove wire from station module. Strip back enough insulation to see 1/8" (3mm) of bare wire when fully inserted. Repair wire connections. Inspect solenoid and repair or replace as necessary.
A station does not turn off.	No station time entered. Valve problem generally caused by a bonnet leak or corroded solenoid.	Enter a station time (See p. 28). Inspect valve bonnet seal and/or solenoid. Replace as needed.
Program starts again after completion of a watering cycle.	Season Adjust setting greater than 100%. Watering programs have overlapping start times (stacked).	Review Season Adjust factor and reset to 100%. (See p. 34) Reduce station times. Change/remove program start times. (See p. 27).

Specifications

Cabinet Dimensions:

Indoor Model

7.5" W x 8.5" H x 2" D
(19cm W x 21.6cm H x 5cm D)

Outdoor Model

13.25" W x 9" H x 3.5" D
(33.7cm W x 22.9cm H x 9cm D)

Temperature Range:

Operating: +14°F to +140°F (-10°C to +60°C)

Storage: -22°F to +149°F (-30°C to +65°C)

Power Specifications:

Indoor Model - North America

Plug-in Transformer, Class 2, UL Listed, CSA-certified

- **Input:** 120 VAC \pm 10%, 50/60 H
- **Output:** 24 VAC \pm 10%, 50/60 Hz, 18 VA

Indoor Model - Europe

Plug-in Transformer, TUV Approved

- **Input:** 230 VAC \pm 10%, 50/60 Hz
- **Output:** 24 VAC \pm 10%, 50/60 Hz, 18 VA

Indoor Model - Australia

Plug-in Transformer, SAA Approved

- **Input:** 240 VAC \pm 10%, 50Hz
- **Output:** 24 VAC \pm 10%, 50 Hz, 18 VA

Outdoor Model - North America

Built-in Transformer, Class 2, UL Listed, CSA Certified

- **Input:** 120 VAC \pm 10%, 50/60 Hz
- **Output:** 24 VAC \pm 10%, 50/60 Hz, 20 VA

Outdoor Model - Europe

Built-in Transformer, TUV Approved, SAA Approved

- **Input:** 230 VAC \pm 10%, 50/60 Hz
- **Output:** 24 VAC \pm 10%, 50/60 Hz, 20 VA

Outdoor Model - Australia

Built-in Transformer, SAA Approved

- **Input:** 240 VAC \pm 10%, 50/60 Hz
- **Output:** 24 VAC \pm 10%, 50/60 Hz, 20 VA

Maximum Load Per Station:

0.50A (12 VA) @ 24 VAC

Maximum Load For Pump/Master Valve:

0.50A (12 VA) @ 24 VAC

Total Maximum Output: 0.70A (16.8 VA) @ 24 VAC

Warranty

The Toro Promise – Limited Three- or Five-year Warranty

The Toro Company and its affiliate, Toro Warranty Company, pursuant to an agreement between them, jointly warrants, to the owner, each new piece of equipment (featured in the current catalog at date of installation) against defects in material and workmanship for a period described below, provided they are used for irrigation purposes under manufacturer's recommended specifications. Product failures due to acts of God (i.e., lightning, flooding, etc.) are not covered by this warranty.

Neither Toro nor Toro Warranty Company is liable for failure of products not manufactured by them even though such products may be sold or used in conjunction with Toro products.

During such warranty period, we will repair or replace, at our option, any part found to be defective. Your remedy is limited solely to the replacement or repair of defective parts.

Return the defective part to your local Toro distributor, who may be listed in your telephone directory Yellow Pages under "Irrigation Supplies" or "Sprinkler Systems," or contact The Toro Warranty Company P.O. Box 489, Riverside, California, 92502.

Phone (800) 664-4740 for the location of your nearest Toro distributor or outside the U.S., call (951) 688-9221.

This warranty does not apply where equipment is used, or installation is performed, in any manner contrary to Toro's specifications and instructions, nor where equipment is altered or modified.

Neither Toro nor Toro Warranty Company is liable for indirect, incidental or consequential damages in connection with the use of equipment, including but not limited to: vegetation loss, the cost of substitute equipment or services required during periods of malfunction or resulting non-use, property damage or personal injury resulting from installer's actions, whether negligent or otherwise.

Some states do not allow the exclusion or limitation of incidental or consequential damages, so the above limitation or exclusion may not apply to you.

All implied warranties, including those of merchantability and fitness for use, are limited to the duration of this express warranty.

Some states do not allow limitations of how long an implied warranty lasts, so the above limitation may not apply to you.

This warranty gives you specific legal rights and you may have other rights which vary from state to state.

The TMC-212 high-surge controller is covered by this warranty for a period of five years from the date of installation.

The TMC-212 standard-surge controller is covered by this warranty for a period of three years from the date of installation.

